

### Features

- Fits minimum 36-inch apron sink base cabinet.
- Large/medium bowls.
- 9-inch depth.
- Self-Trimming apron overlaps the cabinet face for easy installation and beautiful results.
- No faucet holes.
- Smart Divide® features a low dividing barrier that increases workspace and versatility.
- Basin slopes toward drain to minimize water pooling.
- Offset drain increases workspace in the sink and storage space underneath.
- Includes cutout templates.

### Material

- KOHLER® enameled cast iron.

### Installation

- Under-mount apron-front.

### Recommended Products/Accessories

K-9000 P-Trap  
K-5828 Sink Rack  
K-5874 Sink Rack  
K-6377 Sponge Caddy  
K-6378 Kitchen Brush Caddy  
K-6379 Kitchen Squeegee  
K-6382 Disinfecting Wipes Dispenser  
K-6383 Soap Dispenser  
K-8618 Paper Towel Holder  
K-8619 Flexible Kitchen Mat  
K-8624 Dish Scraper  
K-8801 Sink Strainer  
K-8799 Sink Strainer



### Codes/Standards

















ASME A112.19.1/CSA B45.2

### KOHLER® Enameled Cast Iron Kitchen Sink Lifetime Limited Warranty

See website for detailed warranty information.

### Available Colors/Finishes

*Color tiles intended for reference only.*

Color	Code	Description
	0	White
	FF	Sea Salt™
	96	Biscuit
	47	Almond
	FD	Cane Sugar™
	NY	Dune
	95	Ice™ Grey
	G9	Sandbar
	33	Mexican Sand™
	K4	Cashmere
	FT	Basalt
	58	Thunder™ Grey
	20	Suede
	KA	Black 'n Tan
	FP	Caviar
	7	Black Black™

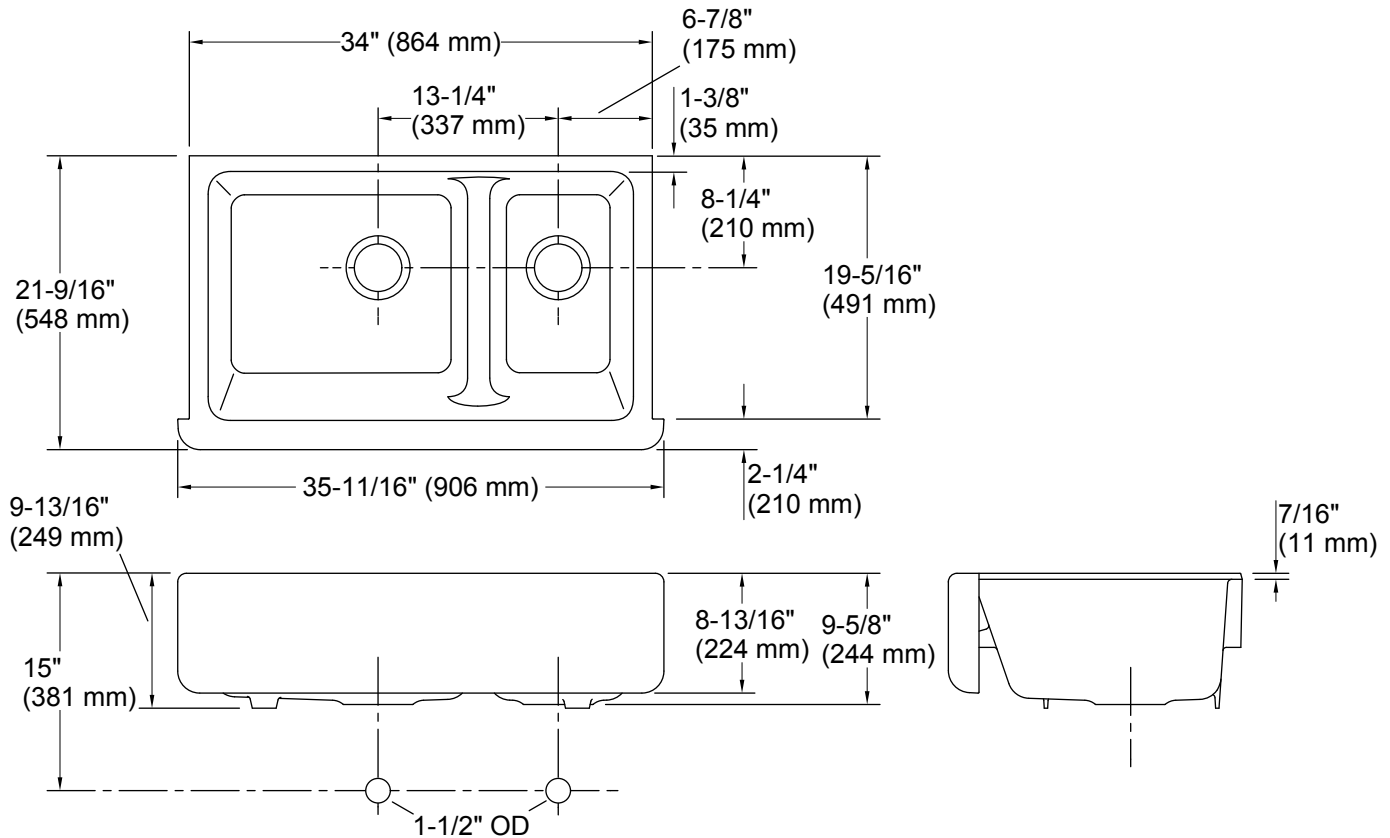

### Technical Information

All product dimensions are nominal.

Bowl configuration:	Off-set Large/small
Installation:	Under-mount
Min. base cabinet width:	36" (914 mm)
Bowl area (Left):	Length: 18-13/16" (478 mm) Width: 18-1/16" (459 mm) Bowl depth: 9" (229 mm) Water depth: 9" (229 mm)
Bowl area (Right):	Length: 10-5/16" (262 mm) Width: 18-1/16" (459 mm) Bowl depth: 9" (229 mm) Water depth: 9" (229 mm)
Drain hole:	3-5/8" (92 mm)

### Notes

Install this product according to the installation instructions.

**NOTICE:** The countertop manufacturer or cutter must use the cut-out template provided with the product, or a current one provided by Kohler Co. (call 1-800-4KOHLER). Kohler Co. is not responsible for cut-out errors when the incorrect cut-out template is used.

**IMPORTANT!** The distance from the top edge of the cabinet to the top of the cabinet door must be at least 9" (229 mm) to install this sink.