

Features

- Frameless, 1/4" (6 mm) thick Crystal Clear tempered glass.
- Innovative roller design simplifies installation and provides out-of-plumb adjustability while glass is installed.
- Cushioned center guide provides smooth, quiet sliding action.
- Vertical blade handles accentuate the contemporary style.
- CleanCoat® nanotechnology provides a smooth, nonstick surface to help prevent buildup of water stains, bacteria and mildew on your glass, to make it easy to clean and keep it looking like new.

Installation

- Sliding shower door.
- Not for use in hospitality.

Recommended Products/Accessories

K-23723 Faucet cleaner

Included Components

Additional Components:
Hardware kit



Codes/Standards

CPSC 16CFR 1201
ANSI Z97.1

KOHLER® One-Year Limited Warranty

See website for detailed warranty information.

Available Colors/Finishes

Color tiles intended for reference only.

Color	Code	Description
	SH	Bright Silver
	MX	Matte Nickel
	ABV	Anodized Brushed Bronze
	ABZ	Anodized Dark Bronze
	BL	Matte Black

Available Glass Options

Code	Description
L	Crystal Clear

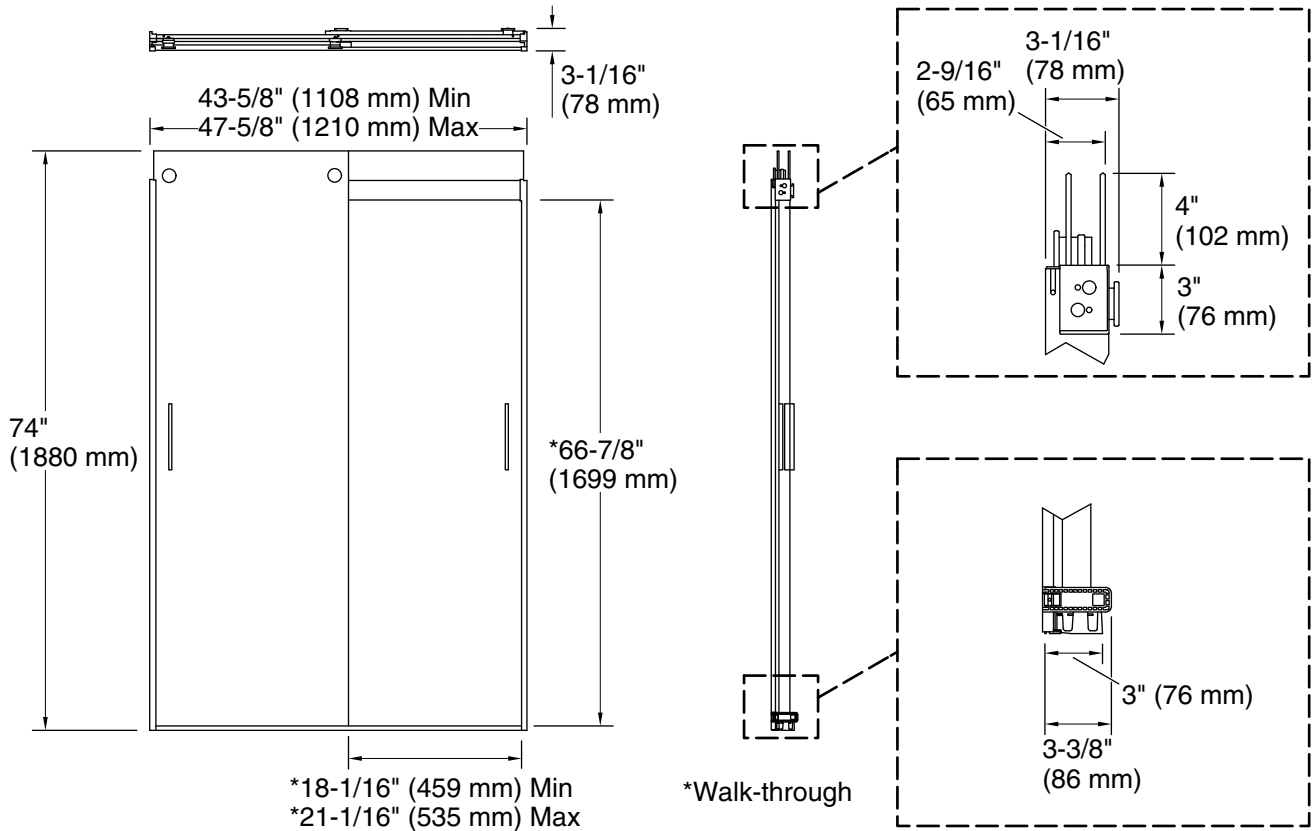

Technical Information

All product dimensions are nominal.

Installation type: For shower base installation

Opening style: Sliding/Bypass

Opening Width - Min: 43-5/8" (1108 mm)

Opening Width - Max: 47-5/8" (1210 mm)

Walk-through - Min: 18-1/16" (459 mm)

Walk-through - Max: 21-1/16" (535 mm)

Base-To-Wall Radius 1/2" (13 mm)

– Max:

Glass thickness: 1/4" (6 mm)

Glass coating: CleanCoat®

Notes

Install this product according to the installation guide.

If replacing a shower door, the narrow wall jamb design of this door may not cover the existing shower door holes.

The vertical opening should be a minimum of 76-1/2" (1943 mm) to allow for installation clearance.